

Rubrik 4.7

90°-Bogen

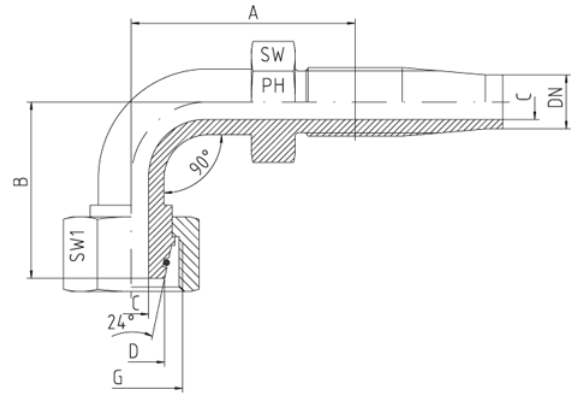
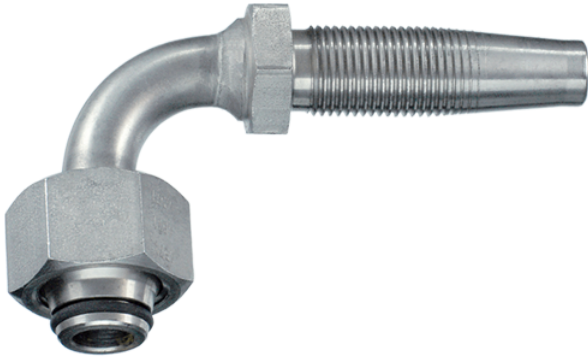

DKOL/DKOS-Nippel - 90°-Bogen Für Gegenanschluss mit 24°-Konus

DIN 2353 / DIN EN ISO 8434-1 Hinweise zur Montage: Das Schlauchnippel-Gewinde unbedingt vor der Montage dick einölen oder einfetten.

(Schmierstoffe Rubrik 12)

O-Ring = NBR

Schlauch	DN	Gewinde	Rohr A.D.	Ca. Maße		Bestellzeichen
DN	in.	G	D	C	SW1	

Reihe L

06	1/4"	M 12 x 1,5	6	4,0	17	SR-DKOL-06-90°-DN 06
06	1/4"	M 14 x 1,5	8	4,0	17	SR-DKOL-08-90°-DN 06
08	5/16"	M 16 x 1,5	10	6,0	19	SR-DKOL-10-90°-DN 08
10	3/8"	M 18 x 1,5	12	7,5	22	SR-DKOL-12-90°-DN 10
12	1/2"	M 22 x 1,5	15	10,0	27	SR-DKOL-15-90°-DN 12
16	5/8"	M 26 x 1,5	18	13,0	32	SR-DKOL-18-90°-DN 16
19	3/4"	M 30 x 2	22	15,5	36	SR-DKOL-22-90°-DN 19
25	1"	M 36 x 2	28	21,5	41	SR-DKOL-28-90°-DN 25

Reihe S

06	1/4"	M 14 x 1,5	6	4,0	17	SR-DKOS-06-90°-DN 06
06	1/4"	M 16 x 1,5	8	4,0	19	SR-DKOS-08-90°-DN 06
06	1/4"	M 18 x 1,5	10	4,0	22	SR-DKOS-10-90°-DN 06
08	5/16"	M 20 x 1,5	12	5,5	24	SR-DKOS-12-90°-DN 08
10	3/8"	M 22 x 1,5	14	7,5	27	SR-DKOS-14-90°-DN 10

12	1/2"	M 24 x 1,5	16	10,0	30	SR-DKOS-16-90°-DN 12
16	5/8"	M 30 x 2	20	13,0	36	SR-DKOS-20-90°-DN 16
19	3/4"	M 36 x 2	25	15,5	46	SR-DKOS-25-90°-DN 19
25	1"	M 42 x 2	30	21,5	50	SR-DKOS-25-90°-DN 21