

Rubrik 8.182

NPT - Innen - OMD

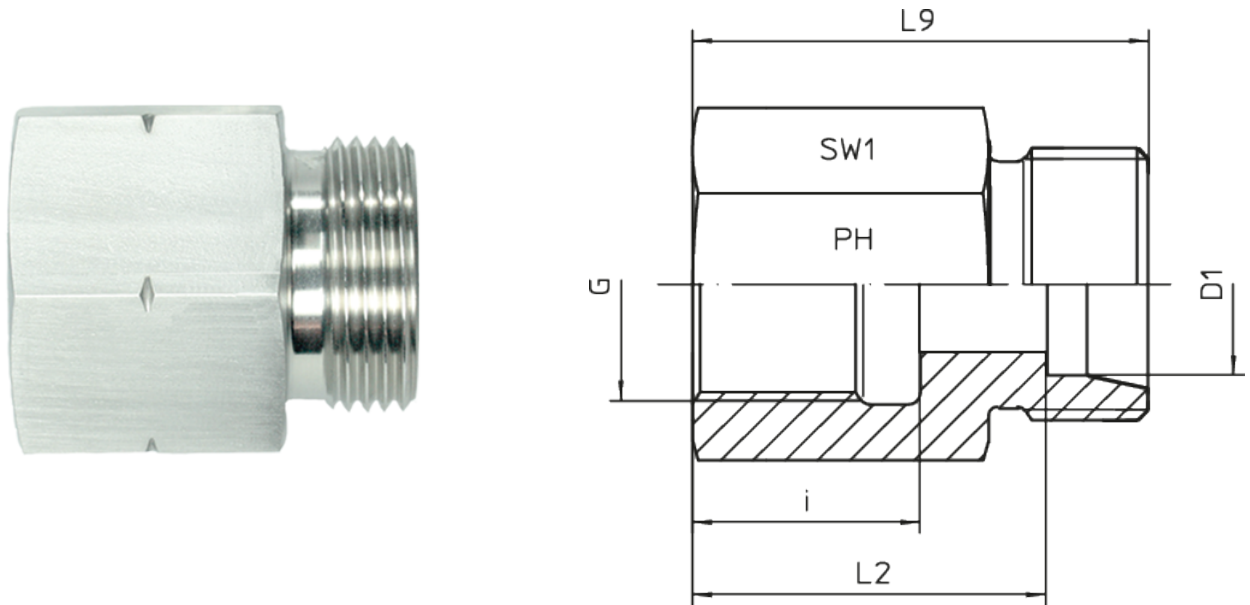

Gerade Aufsraub-Verschraubungsstutzen Innengewinde: NPT

Druck	Rohr A.D.	Gewinde	Ca. Maße				Bestellzeichen
PN	D1	G	L2	L9	i	SW1	

Reihe L

315	6	1/8" NPT	19,0	26,0	11,6	14	GAI-L-06-1/8"-NPT-OMD
315	6	1/4" NPT	23,5	31,0	16,4	19	GAI-L-06-1/4"-NPT-OMD
315	6	3/8" NPT			17,4	24	GAI-L-06-3/8"-NPT-OMD
315	8	1/4" NPT	23,5	31,0	16,4	19	GAI-L-08-1/4"-NPT-OMD
315	8	3/8" NPT	25,0	32,0	17,4	24	GAI-L-08-3/8"-NPT-OMD
315	10	1/4" NPT	24,0	32,0	16,4	19	GAI-L-10-1/4"-NPT-OMD
315	10	3/8" NPT	26,0	33,0	17,4	24	GAI-L-10-3/8"-NPT-OMD
315	10	1/2" NPT			22,6	27	GAI-L-10-1/2"-NPT-OMD
315	12	1/4" NPT	25,0	32,0	16,4	19	GAI-L-12-1/4"-NPT-OMD
315	12	3/8" NPT	27,0	32,0	17,4	24	GAI-L-12-3/8"-NPT-OMD
315	12	1/2" NPT	32,0	39,0	22,6	27	GAI-L-12-1/2"-NPT-OMD
315	15	3/8" NPT	26,0	33,0	17,4	24	GAI-L-15-3/8"-NPT-OMD
315	15	1/2" NPT	33,0	38,0	22,6	27	GAI-L-15-1/2"-NPT-OMD
315	18	1/2" NPT	32,5	40,0	22,6	27	GAI-L-18-1/2"-NPT-OMD
160	22	3/4" NPT	35,5	43,0	23,1	36	GAI-L-22-3/4"-NPT-OMD
160	28	1" NPT	40,5	48,0	27,8	41	GAI-L-28-1"-NPT-OMD
160	35	1 1/4" NPT	40,5	51,0	28,3	55	GAI-L-35-1 1/4"-NPT-OMD
160	42	1 1/2" NPT	42,0	53,0	28,3	55	GAI-L-42-1 1/2"-NPT-OMD

Reihe S

630	6	1/4" NPT	26,0	33,0	16,4	19	GAI-S-06-1/4"-NPT-OMD
630	8	1/4" NPT	26,0	32,0	16,4	19	GAI-S-08-1/4"-NPT-OMD
630	10	3/8" NPT	27,0	34,5	17,4	24	GAI-S-10-3/8"-NPT-OMD
630	12	3/8" NPT	27,5	35,0	17,4	24	GAI-S-12-3/8"-NPT-OMD
630	12	1/2" NPT	33,5	40,0	22,6	27	GAI-S-12-1/2"-NPT-OMD
630	14	1/2" NPT	35,0	41,0	22,6	27	GAI-S-14-1/2"-NPT-OMD
400	16	3/8" NPT	27,5	35,0	17,4	27	GAI-S-16-3/8"-NPT-OMD
400	16	1/2" NPT	34,5	43,0	22,6	27	GAI-S-16-1/2"-NPT-OMD
400	20	3/4" NPT	35,5	45,0	23,1	36	GAI-S-20-3/4"-NPT-OMD
400	25	1" NPT	41,0	53,0	27,8	41	GAI-S-25-1"-NPT-OMD
400	30	1 1/4" NPT	43,5	57,0	28,3	55	GAI-S-30-1 1/4"-NPT-OMD
315	38	1 1/2" NPT	43,0	59,0	28,3	60	GAI-S-38-1 1/2"-NPT-OMD