



EDELSTAHL / STAINLESS STEEL
VERBINDUNGSTECHNIK
FLUID CONNECTORS

Bördelanschlussteile für Verschraubungs- stutzen mit 24°-Innenkonus

Flare Coupling Parts for Coupling Bodies with 24°-Cone





BÖRDELANSCHLUSSTEILE FÜR VERSCHRAUBUNGSSTUTZEN MIT 24°-INNENKONUS

FLARE COUPLING PARTS FOR COUPLING BODIES WITH 24°-CONE

Produktgruppen	Product-Groups	Seite / Page
Montageanleitung	Assembly Instruction	7.2-7.3
Rohranschlusssteile	Tube Connecting Parts	
Überwurfmuttern	Nuts	7.4
Druckringe	Flare Sleeves	7.5
Zwischenringe mit O-Ring	O-ring Adaptors	7.6
Anschlusssteile komplett	Complete Parts	7.7



1.

Rohr rechtwinklig absägen (keinen Rohrabschneider verwenden).

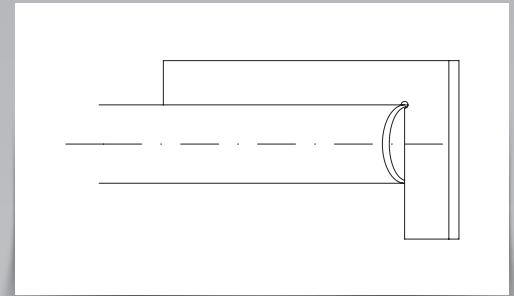

2.

Innen und außen leicht entgraten, nicht anfasen. Rohrende reinigen, da sonst die Dichtfläche des Rohres beim Bördeln beschädigt wird.

3.

Überwurfmutter und Druckring nach Abbildung auf das Rohr schieben.

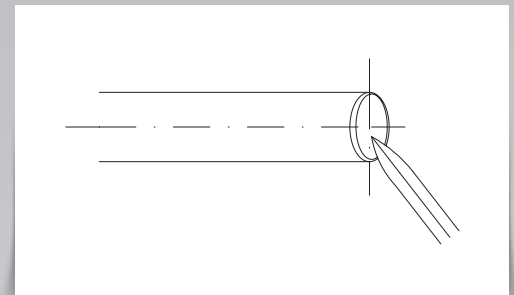

4.

Rohr mit Bördelwerkzeug oder Maschine bördeln. Der Bördeldurchmesser DB darf nicht außerhalb der in der Tabelle angegebenen Grenzen liegen. Der Bördelkegel muss rechtwinklig zur Rohrachse und zentrisch zum Druckring sein, der Innenkegel riefenfrei und sauber.

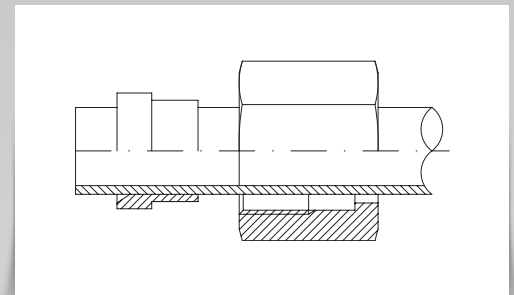

5.

Bei Edelstahl-Verschraubungen müssen die Gewinde geschmiert werden (wie z.B. Gleitmo 810 oder High Tech Paste ASW 040 P; siehe Kapitel 12). Es handelt sich hierbei um spezielle Schmierstoffe für Edelstahl-Verschraubungen.

6. / 7.

Zwischenring in Verschraubungsstutzen einpressen und das aufgebördelte Rohr an den Zwischenring andrücken. Überwurfmutter handfest anziehen. Überwurfmutter mit dem Schlüssel anziehen bis der Zwischenring unverlierbar in den Stutzen gepresst ist. Bei Kraft anstieg die Überwurfmutter um ca. 1/4 Umdrehung weiter anziehen.

Nach jedem Lösen der Verbindung ist der Wiederanzug ohne erhöhten Kraftaufwand vorzunehmen.

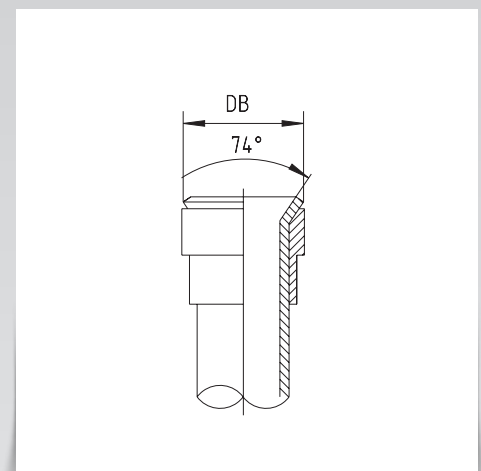

Rohr A.D. / Tube O.D.	6	8	10	12	14	15	16	18
DB min.	9,1	11,3	13,1	15,3	18,6	19,1	20,6	23,2
DB max.	10,0	12,0	14,0	16,0	19,6	20,0	22,0	24,0
Rohr A.D. / Tube O.D.	20	22	25	28	30	35	38	42
DB min.	25,6	26,5	31,1	32,7	37,0	41,8	46,0	48,8
DB max.	26,8	27,5	33,0	33,3	38,7	42,7	47,2	49,8

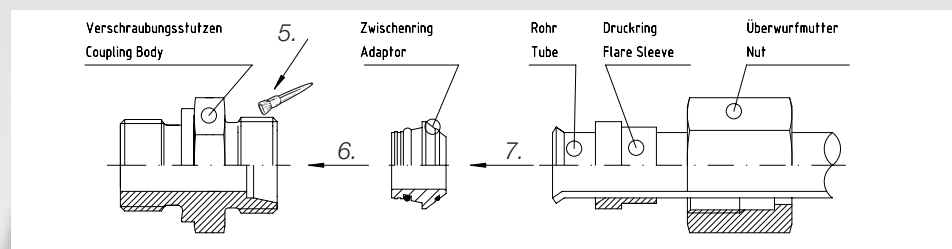

1.

Cut the tube square (do not use a pipe cutter).

2.

Deburr the pipe inside and outside, do not chamfer. Clean the tube end, otherwise the sealing surface of the tube will be damaged when it is flared.

3.

Slide the nut and the collar over the tube as shown in the illustration.

4.

Flare the tube by means of flaring tools or a flaring machine. The flare diameter DB must not be out of the limits given in the table. The flare cone must be square to the tubular axle and concentric to the collar. The inner cone must be clean and free of flutes.

5.

Stainless steel fittings must be lubricated at the thread (for example use Gleitmo 810 or High Tech Paste ASW 040 P; see category 12).

These are special lubricants for Stainless Steel fittings.

6. / 7.

Press the adaptor into the coupling body and press flared tube onto the adaptor. Screw the nut on by hand. Tighten the nut with a spanner until the adaptor is pressed captively into the coupling body. When torque must be intensified, tighten the nut approx. 1/4 turn more.

Each time the connection is detached, it must be retightened without any intensified torque.

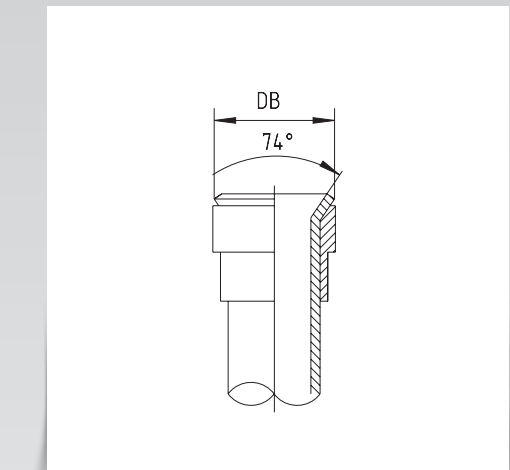
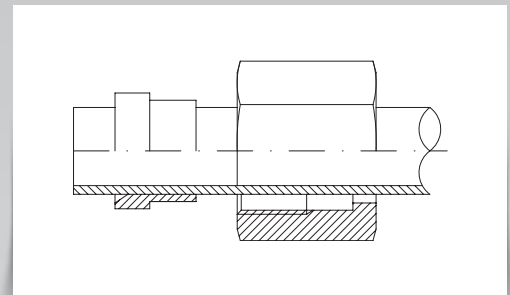
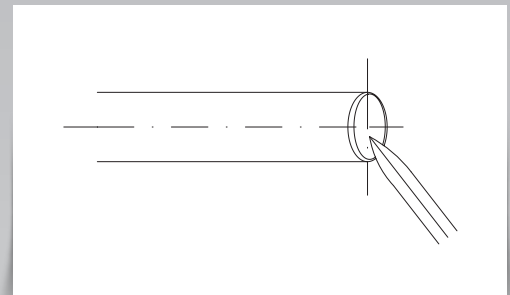
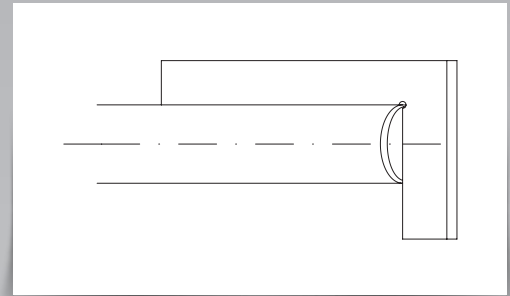

Rohr A.D. / Tube O.D.	6	8	10	12	14	15	16	18
DB min.	9,1	11,3	13,1	15,3	18,6	19,1	20,6	23,2
DB max.	10,0	12,0	14,0	16,0	19,6	20,0	22,0	24,0
Rohr A.D. / Tube O.D.	20	22	25	28	30	35	38	42
DB min.	25,6	26,5	31,1	32,7	37,0	41,8	46,0	48,8
DB max.	26,8	27,5	33,0	33,3	38,7	42,7	47,2	49,8

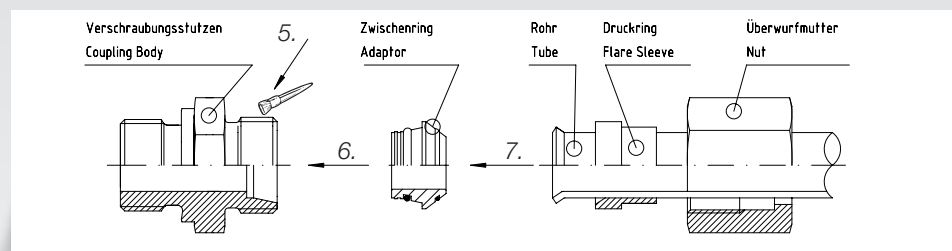

Überwurfmuttern

Für Bördelverschraubungen 37° und
Verschraubungsstützen mit 24°-Innenkonus
Bohrungsform W DIN 3861

(1) Bei Inanspruchnahme von 420 bar ist der sonst
übliche Sicherheitsfaktor 4 auf 3 zu reduzieren.

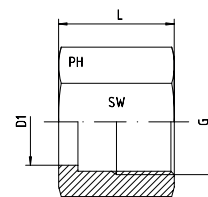

Nuts

For Flare Couplings 37° and Coupling Bodies
with 24°-Cone
Type of Port End W DIN 3861

(1) In the 420 bar section, the normal safety factor
of 4:1 is reduced to 3:1.

Reihe / Series L

Druck Pressure	Rohr A.D. Tube O.D.	Gewinde Thread	Ca. Maße Approx. Dimensions	Bemerkungen Notes	Bestellzeichen Order-Code	Brutto-Preis Gross-Price
PN	D1 + Tol.	G	L	SW		Euro (€)
500	6,0	M 12 x 1,5	17,0	14	BM-06-L	2,43
500	8,0	M 14 x 1,5	18,0	17	BM-08-L	3,32
500	10,0	M 16 x 1,5	19,5	19	BM-10-L	3,58
400	12,0	M 18 x 1,5	20,5	22	BM-12-L	4,22
400	15,0	M 22 x 1,5	23,0	27	BM-15-L	5,68
400	18,0	M 26 x 1,5	23,0	32	BM-18-L	8,44
315	22,0	M 30 x 2	27,5	36	BM-22-L	11,25
250	28,0	M 36 x 2	27,5	41	BM-28-L	19,17
250	35,0	M 45 x 2	30,0	50	BM-35-L	28,07
250	42,0	M 52 x 2	34,0	60	BM-42-L	37,07

Reihe / Series S

Druck Pressure	Rohr A.D. Tube O.D.	Gewinde Thread	Ca. Maße Approx. Dimensions	Bemerkungen Notes	Bestellzeichen Order-Code	Brutto-Preis Gross-Price
PN	D1 + Tol.	G	L	SW		Euro (€)
800	6,0	M 14 x 1,5	18,0	17	BM-06-S	3,32
800	8,0	M 16 x 1,5	20,0	19	BM-08-S	3,83
800	10,0	M 18 x 1,5	20,5	22	BM-10-S	4,35
630	12,0	M 20 x 1,5	21,0	24	BM-12-S	4,60
630	14,0	M 22 x 1,5	23,0	27	BM-14-S	7,62
630	16,0	M 24 x 1,5	26,5	30	BM-16-S	7,80
420	20,0	M 30 x 2	27,5	36	BM-20-S	11,76
420	25,0	M 36 x 2	30,5	46	BM-25-S	21,73
420	30,0	M 42 x 2	32,0	50	BM-30-S	33,34
420 (1)	38,0	M 52 x 2	38,0	60	BM-38-S	41,42

Druckringe

Für Bördelverschraubungen 37° und
 Verschraubungsstützen mit 24°-Innenkonus
 Bohrungsform W DIN 3861

(1) Bei Inanspruchnahme von 420 bar ist der sonst
 übliche Sicherheitsfaktor 4 auf 3 zu reduzieren.

Flare Sleeves

For Flare Couplings 37° and Coupling Bodies
 with 24°-Cone
 Type of Port End W DIN 3861

(1) In the 420 bar section, the normal safety factor
 of 4:1 is reduced to 3:1.

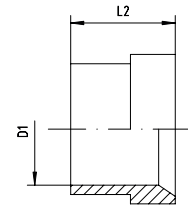

Reihe / Series L

Druck Pressure	Rohr A.D. Tube O.D.	Ca. Maße Approx. Dimensions	Bemerkungen Notes	Bestellzeichen Order-Code	Brutto-Preis Gross-Price
PN	D1 + Tol.	L2			Euro (€)
500	6	10,5		DR-06-L	2,10
500	8	11,0		DR-08-L	2,43
500	10	12,5		DR-10-L	2,68
400	12	13,0		DR-12-L	3,20
400	15	14,0		DR-15-L	3,71
400	18	14,5		DR-18-L	4,22
315	22	18,0		DR-22-L	4,47
250	28	17,0		DR-28-L	6,26
250	35	19,0		DR-35-L	12,19
250	42	21,0		DR-42-L	18,71

Reihe / Series S

Druck Pressure	Rohr A.D. Tube O.D.	Ca. Maße Approx. Dimensions	Bemerkungen Notes	Bestellzeichen Order-Code	Brutto-Preis Gross-Price
PN	D1 + Tol.	L2			Euro (€)
800	6	10,5		DR-06-S	2,17
800	8	11,0		DR-08-S	2,43
800	10	12,5		DR-10-S	2,68
630	12	13,0		DR-12-S	3,20
630	14	14,5		DR-14-S	3,71
630	16	17,0		DR-16-S	3,83
420	20	17,5		DR-20-S	4,35
420	25	20,0		DR-25-S	6,65
420	30	21,5		DR-30-S	10,74
420 (1)	38	26,5		DR-38-S	21,47

Zwischenringe mit O-Ring - NBR
Viton - Auf Anfrage
Für Bördelverschraubungen 37° und
Verschraubungsstützen mit 24°-Innenkonus
Bohrungsform W DIN 3861

(1) Bei Inanspruchnahme von 420 bar ist der sonst
übliche Sicherheitsfaktor 4 auf 3 zu reduzieren.

O-ring Adaptors - NBR
Viton - On Request
For Flare Couplings 37° and Coupling Bodies
with 24°-Cone
Type of Port End W DIN 3861

(1) In the 420 bar section, the normal safety factor
of 4:1 is reduced to 3:1.

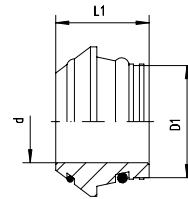

Reihe / Series L

Druck Pressure	Rohr A.D. Tube O.D.	Ca. Maße Approx. Dimensions	Bemerkungen Notes	Bestellzeichen Order-Code	Brutto-Preis Gross-Price
PN	D1	d	L1		Euro (€)
500	6	3	11,5	ZR-06-L	6,95
500	8	5	12,0	ZR-08-L	8,39
500	10	6	12,5	ZR-10-L	8,39
400	12	8	12,5	ZR-12-L	8,95
400	15	11	12,5	ZR-15-L	10,76
400	18	14	13,0	ZR-18-L	12,17
315	22	17	14,2	ZR-22-L	13,73
250	28	23	14,7	ZR-28-L	15,47
250	35	28	18,5	ZR-35-L	22,68
250	42	35	20,5	ZR-42-L	28,25

Reihe / Series S

Druck Pressure	Rohr A.D. Tube O.D.	Ca. Maße Approx. Dimensions	Bemerkungen Notes	Bestellzeichen Order-Code	Brutto-Preis Gross-Price
PN	D1	d	L1		Euro (€)
800	6	3	11,5	ZR-06-S	6,95
800	8	5	12,0	ZR-08-S	8,39
800	10	6	12,5	ZR-10-S	8,39
630	12	8	12,5	ZR-12-S	8,95
630	14	9	14,0	ZR-14-S	11,76
630	16	11	15,0	ZR-16-S	10,99
420	20	14	18,5	ZR-20-S	14,32
420	25	19	20,0	ZR-25-S	16,46
420	30	23	22,0	ZR-30-S	22,37
420(1)	38	30	26,0	ZR-38-S	26,38

Anschlusssteile komplett
Für Bördelverschraubungen 37° und
Verschraubungsstützen mit 24°-Innenkonus
Bohrungsform W DIN 3861

(1) Bei Inanspruchnahme von 420 bar ist der sonst
übliche Sicherheitsfaktor 4 auf 3 zu reduzieren.

Complete Parts
For Flare Couplings 37° and Coupling Bodies
with 24°-Cone
Type of Port End W DIN 3861

(1) In the 315 bar section, the normal safety factor
of 4:1 is reduced to 3:1.

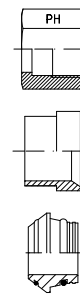

Reihe / Series L

Druck Pressure	Rohr A.D. Tube O.D.	Gewinde Thread	Ca. Maße Approx. Dimensions					Bestellzeichen Order-Code	Brutto-Preis Gross-Price
PN	D1 + Tol.	G	d	L	L1	L2	SW		Euro (€)
500	6	M 12 x 1,5	3	17,0	11,5	10,5	14	BAN-06-L	11,48
500	8	M 14 x 1,5	5	18,0	12,0	11,0	17	BAN-08-L	14,14
500	10	M 16 x 1,5	6	19,5	12,5	12,5	19	BAN-10-L	14,65
400	12	M 18 x 1,5	8	20,5	12,5	13,0	22	BAN-12-L	16,36
400	15	M 22 x 1,5	11	23,0	12,5	14,0	27	BAN-15-L	20,15
400	18	M 26 x 1,5	14	23,0	13,0	14,5	32	BAN-18-L	24,82
315	22	M 30 x 2	17	27,5	14,2	18,0	36	BAN-22-L	29,45
250	28	M 36 x 2	23	27,5	14,7	17,0	41	BAN-28-L	40,90
250	35	M 45 x 2	28	30,0	18,5	19,0	50	BAN-35-L	62,94
250	42	M 52 x 2	35	34,0	20,5	21,0	60	BAN-42-L	84,03

Reihe / Series S

Druck Pressure	Rohr A.D. Tube O.D.	Gewinde Thread	Ca. Maße Approx. Dimensions					Bestellzeichen Order-Code	Brutto-Preis Gross-Price
PN	D1 + Tol.	G	d	L	L1	L2	SW		Euro (€)
800	6	M 14 x 1,5	3	18,0	11,5	10,5	17	BAN-06-S	12,45
800	8	M 16 x 1,5	5	20,0	12,0	11,0	19	BAN-08-S	14,65
800	10	M 18 x 1,5	6	20,5	12,5	12,5	22	BAN-10-S	15,42
630	12	M 20 x 1,5	8	21,0	12,5	13,0	24	BAN-12-S	16,75
630	14	M 22 x 1,5	9	23,0	14,0	14,5	27	BAN-14-S	23,09
630	16	M 24 x 1,5	11	26,5	15,0	17,0	30	BAN-16-S	22,63
420	20	M 30 x 2	14	27,5	18,5	17,5	36	BAN-20-S	30,42
420	25	M 36 x 2	19	30,5	20,0	20,0	46	BAN-25-S	44,84
420	30	M 42 x 2	23	32,0	22,0	21,5	50	BAN-30-S	66,44
420 (1)	38	M 52 x 2	30	38,0	26,0	26,5	60	BAN-38-S	89,27

